

FLASH

SCHEDA TECNICA-DATA SHEET

Lampade stroboscopiche allo xeno - Stroboscopic xeno lamps



COLLEGAMENTO CONNECTION

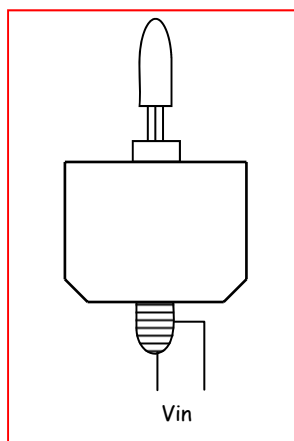

DIMENSIONI (mm) DIMENSION (mm)

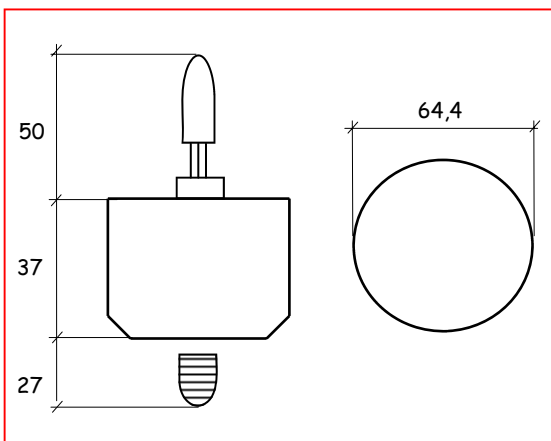

DIMENSIONI con COPERTURA (mm) DIMENSION with CAP (mm)

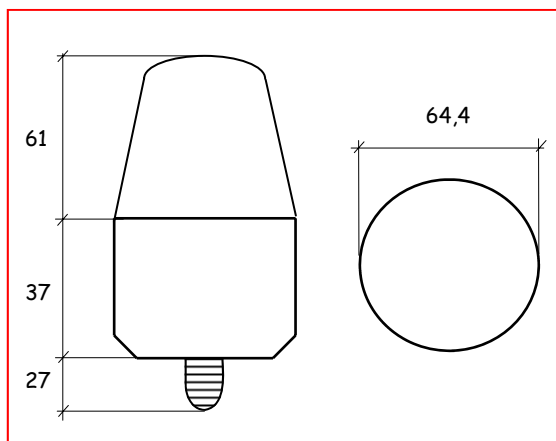

Lampada stroboscopica a risparmio energetico

Saving Energy stroboscopic lamp

Attacco E27

E27 socket

Disponibile con parti elettroniche completamente resinate

Suitable with fully resin electronics parts

Coperture colorate a richiesta

(ROSSO-GIALLO-VERDE-ARANCIONE-BIANCO-BLU

Colored cops on request

(RED-YELLOW-GREEN-ORANGE-WHITE-BLUE

COPERTURE PER 6J - 6J CAP

Code	COLOUR
B0073/BI	BIANCO - WHITE
B0073/BL	BLU - BLUE
B0073/A	ARANCIONE - ORANGE
B0073/R	ROSSO - RED
B0073/G	GIALLO - YELLOW
B0073/V	VERDE - GREEN

IP 20

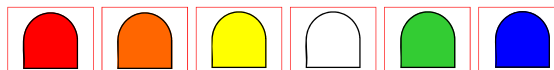

Codice - Code		83.006J/V230
Tensione di alimentazione - Supply Voltage	V	230Vac
Corrente nominale - Nominal current	A	0,02
Lampade - Lamps	JOULE	6
N° di lampeggi al minuto - N° of minute flash		40
Temperatura ambiente min/max - Min/Max ambient temperature	°C	50
Contenitore autoestinguente - Self extinguishing case		94 V0

MADE IN ITALY