

FLASH

SCHEDA TECNICA-DATA SHEET

Lampade stroboscopiche allo xeno - Stroboscopic xeno lamps



COLLEGAMENTO CONNECTION

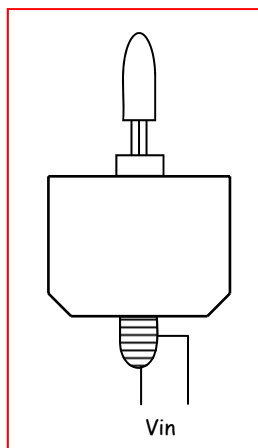

DIMENSIONI (mm) DIMENSION (mm)

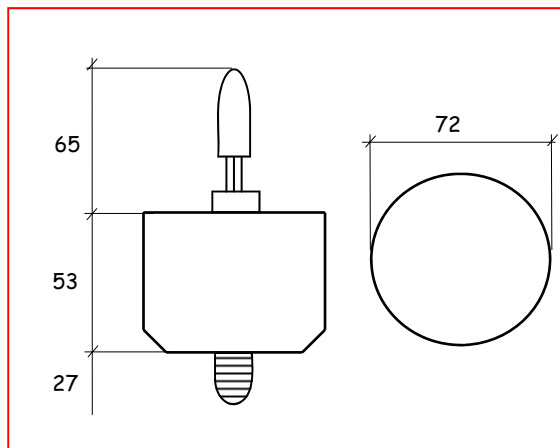

- Lampada stroboscopica a risparmio energetico
- *Saving Energy stroboscopic lamp*
- Attacco E27
- *E27 socket*
- Disponibile con parti elettroniche resinate
- *Suitable with fully resin electronics parts*
- Possibilità di variare il numero di lampeggi
- *Suitable with different N° flash/minute*

IP 20



Codice - Code		83.020J/V110
Tensione di alimentazione - Supply Voltage	V	110Vac
Corrente nominale - Nominal current	A	0,1
Lampade - Lamps	JOULE	20
N° di lampeggi al minuto - N° of minute flash		30
Temperatura ambiente min/max - Min/Max ambient temperature	°C	50
Contenitore autoestinguente - Self extinguishing case		94 V0

MADE IN ITALY